

에코패드 PK시리즈

패드		자바라형 패드	PKBG
		평형 패드	PKMG

특장점

- 고무와 금속의 분리 처리가 가능
패드(고무)와 연결나사(금속)의 2가지 부품으로 구성.
- 패드 내면에 미끄럼 방지용 홈 설치
수분이나 유분이 있는 워크의 경우에, 그립력이 증가하여 옆으로의 미끄러짐을 방지.
- 2경도 고무 패드
고정부는 경도를 높여주고, 흡착부는 부드럽게 하여 확실한 흡착을 실현.

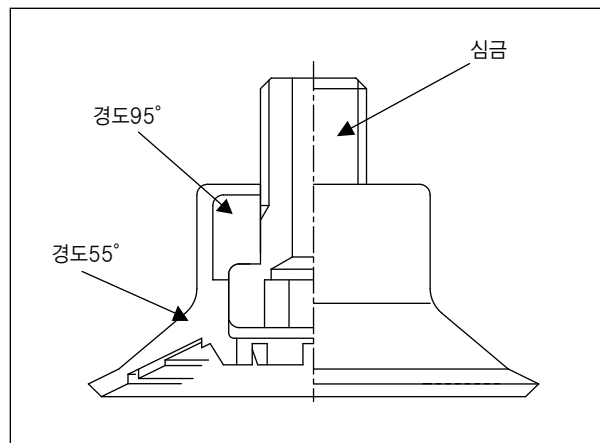

에코 패드 / PKB · MG

형식번호

PK ^①M ^②G - 60 - ^③W

①패드 형상

B	자바라형 패드
M	평형 패드

②패드경

30	∅30(평형만)
30T	∅30(평형만)
40	∅40(평형만)
40T	∅40(평형만)
50	∅50(자바라형만)
50M	∅50(평형만)
50T	∅50(평형만)
60	∅60
60T	∅60(평형만)
75	∅75(평형만)
75T	∅75(평형만)
80	∅80(자바라형만)
80H	∅80(3 단 자바라형)
85K	∅85(평형만)
100	∅100(평형만)
100K	∅100(평형만)
100T	∅100(평형만)
110	∅110(자바라형만)

③패드 고무 재질

W	니트릴 2 경도 55°/95°
---	------------------

패드 표준 사양

기호	재질	경도 (Hs)	사용 온도 범위	색
W	니트릴 2 경도	A55 · 95/S	-26 ~ 120℃	흑색

금구 대응 일람

형식번호	자바라형 패드					평형 패드														
	50	60	80	80H	110	30	30T	40	40T	50M	50T	60	60T	75	75T	85K	100	100K	100T	
TN-PKM-30-M10						○	○	○	○		○									
TN-PK-100-M10	○	○	○	○	○					○		○	○	○	○	○	○	○	○	○
TN-PK-100-M10F	○	○	○	○	○					○		○	○	○	○	○	○	○	○	○
TN-PK-100-M12	○	○	○	○	○					○		○	○	○	○		○		○	○
TN-PK-6710	○	○	○	○	○					○		○	○	○	○		○		○	○

외형치수도

(mm)

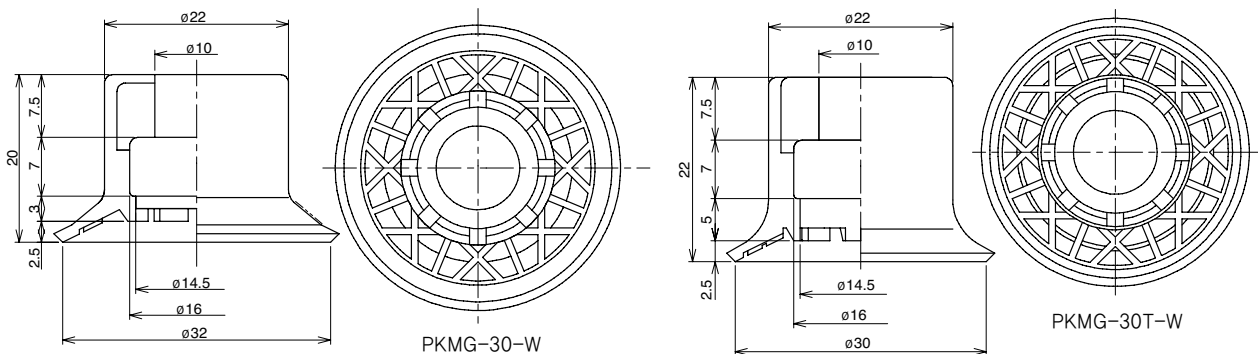

진공패드

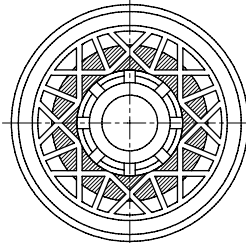
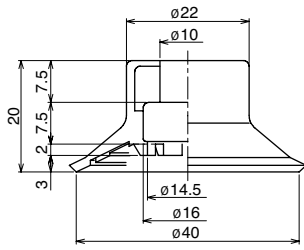

PKMG-40-W

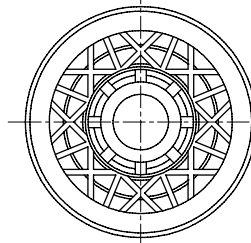
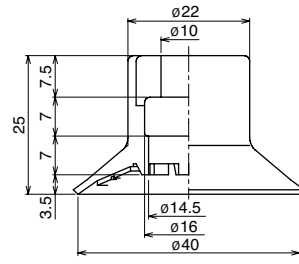

PKMG-40T-W

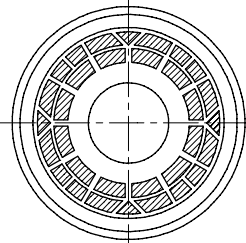
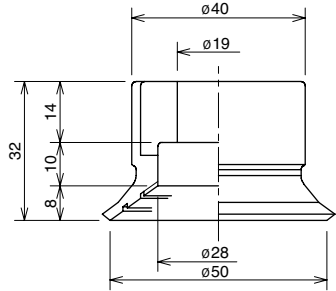

PKMG-50M-W

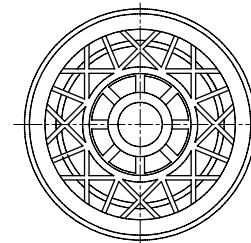
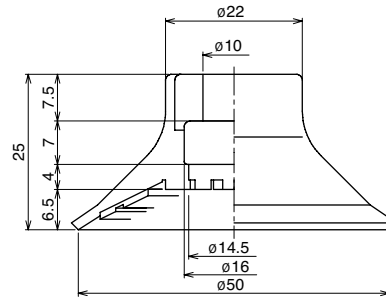

PKMG-50T-W

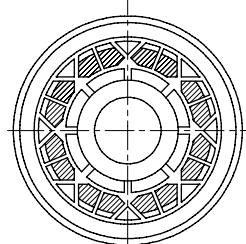
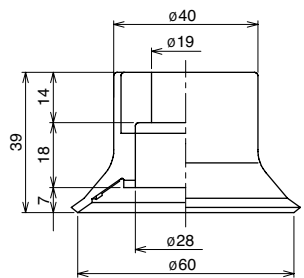

PKMG-60-W

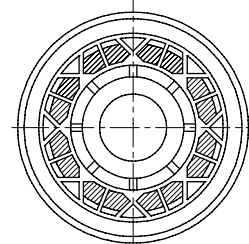
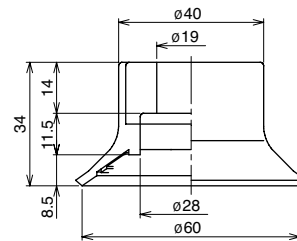

PKMG-60T-W

외형치수도

(mm)

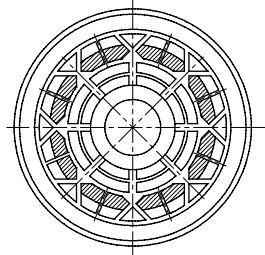
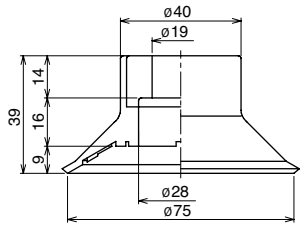

PKMG-75-W

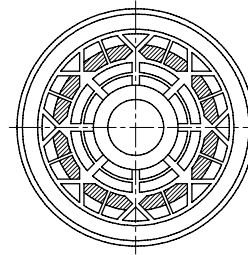
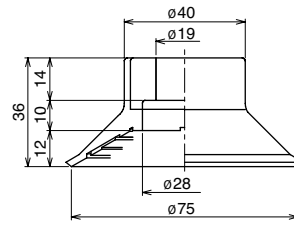

PKMG-75T-W

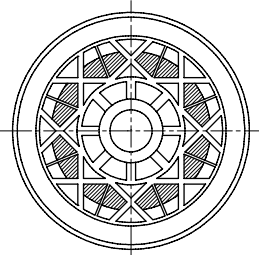
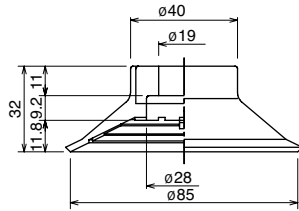

PKMG-85K-W

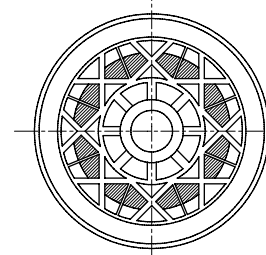
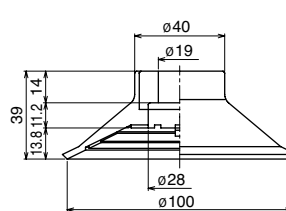

PKMG-100-W

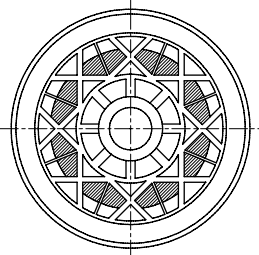
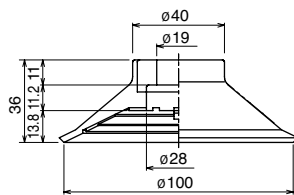

PKMG-100K-W

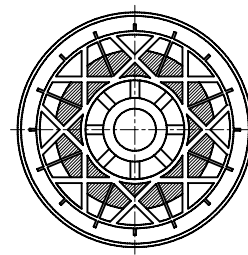
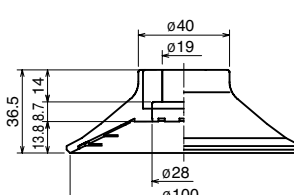

PKMG-100T-W

외형치수도

(mm)

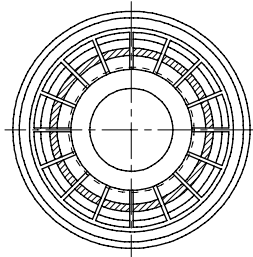
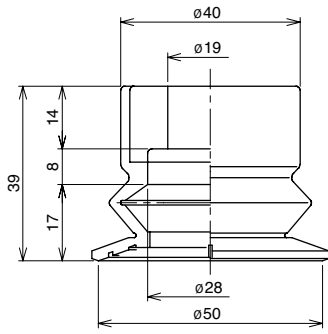

PKBG-50-W

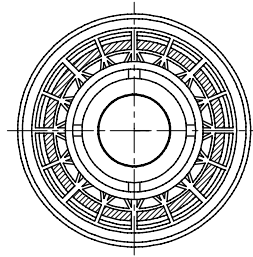
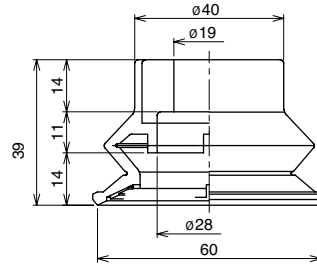

PKBG-60-W

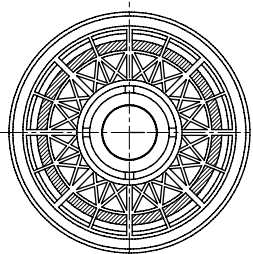
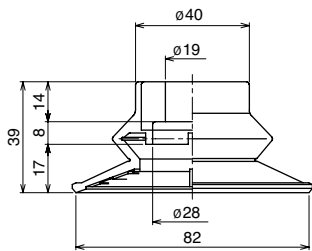

PKBG-80-W

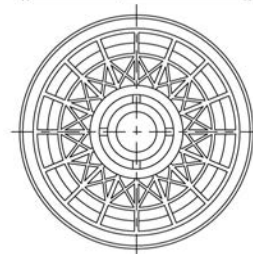
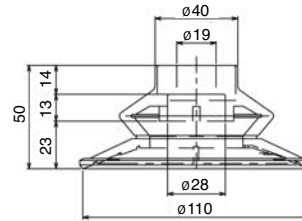

PKBG-110-W

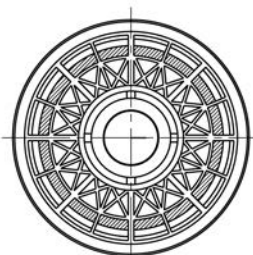
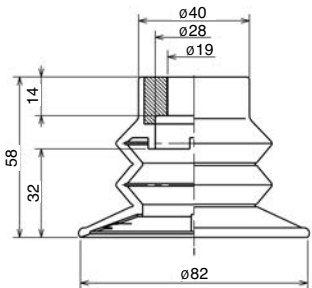

PKBG-80H-W